

© Copyright

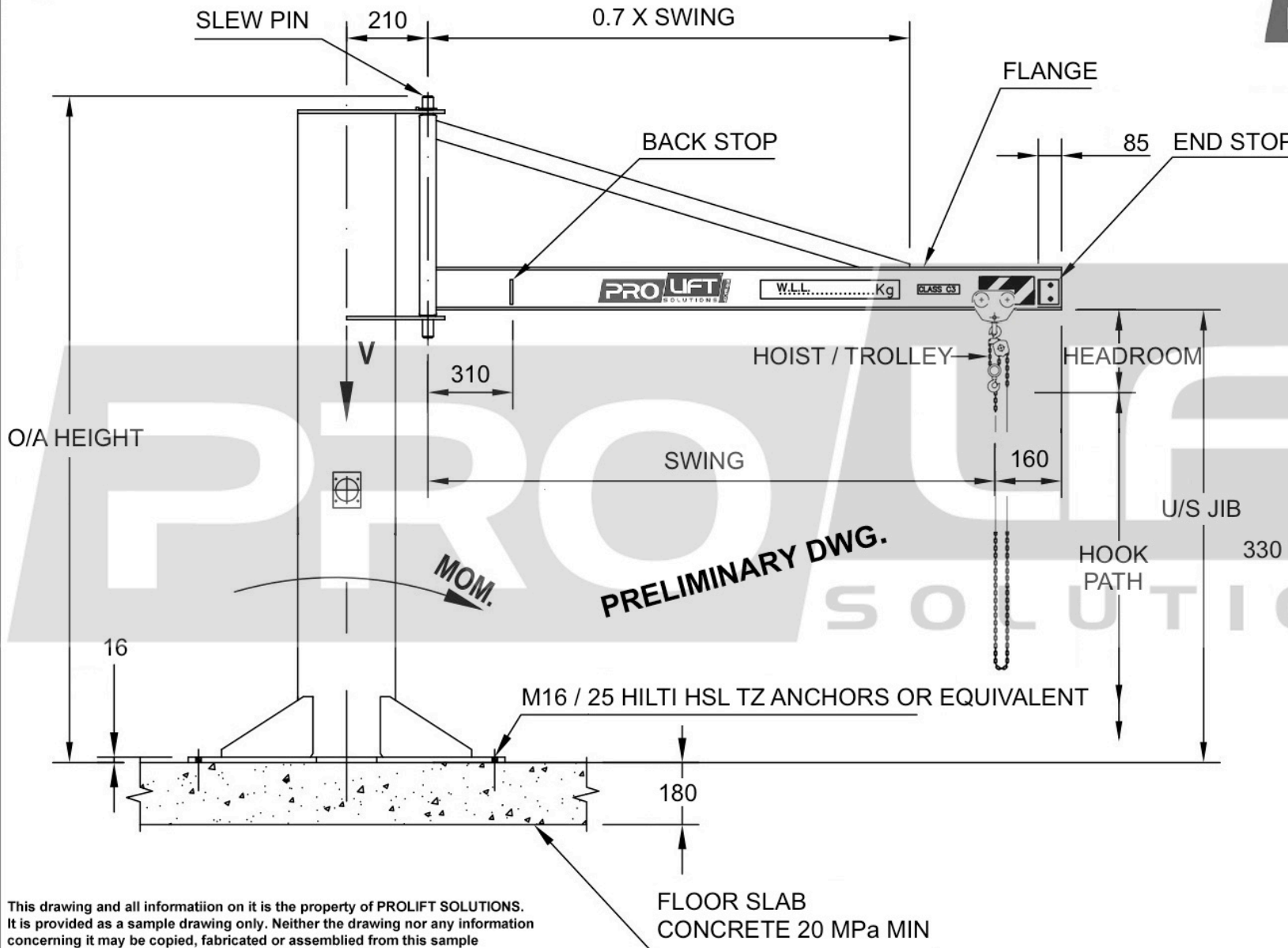

PRELIMINARY DWG.

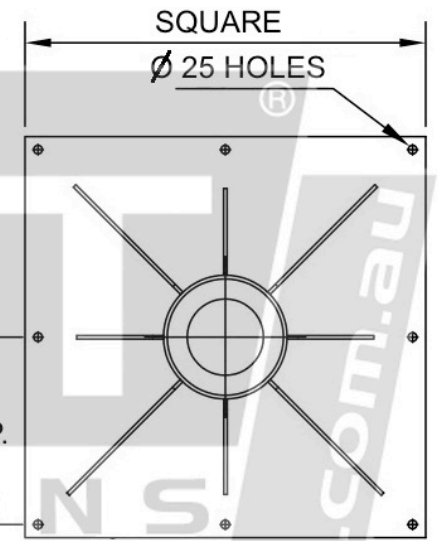

CAPACITY:	125 kg
SWING:	4500 mm
U/S JIB:	3500 mm
SLEW DEGREES:	270 °
O/A HEIGHT:	U/S JIB+773 mm
SQ. BASE PL:	720 mm

This drawing and all information on it is the property of PROLIFT SOLUTIONS. It is provided as a sample drawing only. Neither the drawing nor any information concerning it may be copied, fabricated or assembled from this sample drawing without the written consent of PROLIFT SOLUTIONS.